



CLIMATE CEILING SYSTEMS

Tailor made climate ceiling solutions for a pleasant room climate

« Feel good inside » that's our promise

We offer advice to our partners throughout the construction process – from the initial design until commissioning. During the design phase of your project, we will provide you with documentation on sustainable building design, recommendations for low energy systems and cost estimates for the various solutions.

Whilst developing your building concept, we will help you decide on the room climate criteria, based on the user requirements in relation to thermal comfort.

Our climate ceilings impress, thanks to their high energy efficiency. This allows the user to set higher system temperatures (water, air) for cooling than with conventional systems. Conversely, system temperatures can be set lower for heating. These advantages result in very high energy savings across all system operating phases.

A further advantage is the thermal comfort afforded by the system. Rooms in which the temperature is controlled by a climate ceiling are very comfortable because they are not affected by draughts and the climate heating or cooling is perceived as very natural and pleasant.

- **Competent support across every project phase**
competence forms our basis and delivers your benefit
- **Flexible systems** which can be tailored to the specific requirements of your project
- **Efficient execution** that brings you advantages – because time is an important economic factor

We look forward to a long and successful collaboration with you!

Digital overview brochure



Tailor made climate ceiling solutions

Professional - Flexible - Efficient

April 2026

CONTENTS

Professional - Flexible - Efficient	6
Sustainability at Swegon	
Environmental Product Declarations (EPD).....	8
Building mass connection.....	8
RYKO ceiling system.....	9
Carbon-reduced steel for climate ceilings.....	9
Physical principles	
Climate cooling.....	10
Climate ceiling systems and their advantages.....	10
Sound absorption.....	11
Hybrid systems with building mass connection	
U4X Hybrid system.....	12/52
FAVO Hybrid system.....	14/52
CAURUS Hybrid system.....	16/52
AQUILO Hybrid system.....	18/53
VENTAMIC Hybrid system.....	20/53
Climate sails and modules	
A11-S Climate metal ceiling sail.....	22/54
SPECTRA M-S Climate metal ceiling sail.....	24/54
VARICOOL TKM Climate textile ceiling sail*.....	26/54
AKUSTIKTHERM (TABS).....	28/55
Closed climate ceilings	
A11-C Climate metal ceiling.....	30/56
SPECTRA M-C Climate metal ceiling.....	32/56
ECO M-C Climate metal ceiling**.....	34/56
VARICOOL UNI Climate ceiling jointless.....	36/57
VARICOOL AP Climate ceiling jointless.....	38/57
ARCHISONIC® Acoustic baffle.....	40/57
High performance modules/Climate baffle	
ALBATROS High performance module.....	42/58
OPTI Y High performance module.....	44/58
SOFTLINE High performance module.....	46/58
SOFTLINE WOOD High performance module ..	48/59
METAL LINE Climate baffle.....	50/59
Room management system	
WISE/SuperWISE.....	60

Symbols

Water



Cooling/heating



Acoustics



Integral components



Building mass connection



Invisible air intake



*Currently only available in Switzerland

**Currently not available in Switzerland

Optimal indoor climate with Barcol-Air products

The ideal room climate is a must for wellbeing in offices, conference rooms and hotels.

Our climate ceiling systems for heating and cooling are inspired by the natural heat radiation of the sun and are based on extremely efficient heat transfer. The systems operate with over 60 % radiation, whilst the rest is accounted for by natural convection. This form of thermal transfer makes it possible to achieve optimum temperature control in the room. More energy efficient room temperature settings are possible in both summer and winter time, without impacting comfort.

Thanks to the radiation principle, surface temperatures in the room are regulated without generating noise or draughts, making it possible to keep the air temperature slightly lower when heating and slightly higher when cooling than with conventional systems. These systems also work perfectly with renewable energy systems such as heat pumps, which leads to lower energy consumption and the associated reduction in operating costs

Our versatile climate ceiling systems are suitable for a range of ceiling constructions including metal ceiling systems, free-hanging sails and special geometries. A further area of application is the thermal activation of plasterboard ceilings, which can be used to create large, jointless ceiling installations.

« The best indoor climate for people and the environment »



Professional - Flexible - Efficient

Comprehensive project management – we pursue our passion and ease your burden

We offer advice to our partners throughout the construction process – from the initial design until the building is in use. During the design phase of your project, we will provide you with documentation on sustainable building design, recommendations for low energy systems and cost estimates for the various solutions. Whilst developing your building concept, we will help you decide on the room climate and thermal comfort criteria, based on the user requirements in relation to heating and cooling.

Modern production centre in Germany

Our own production centre for climate ceiling systems guarantees the manufacture of high quality systems, both in terms of materials and production technology. Furthermore, customers can also benefit from a high degree of delivery flexibility and unbeatable delivery punctuality.



Play Video

- CNC-controlled production plant
- Laser spot welding process
- Modern production processes
- Interface to Clim@Tool

Research & development

We operate a climate laboratory at our headquarter in Switzerland for product development, where it also carries out various measurements and analyses at project-specific level. This means it is possible to test and confirm the faultless functionality of the solutions as early as the planning phase.



Play Video

- Proof of performance of project-specific climate ceiling solutions
- Static and dynamic performance measurements of climate ceiling systems
- Indoor air speed and thermal comfort measurements
- Special measurements (e.g. control strategy, cold air drop, etc.)

3D design with BIM

Building Information Modeling (BIM) is a digital, model-based planning method for buildings (and other structures) that is used to create and manage data in a 3D model and remains usable from the planning, construction and throughout the operational process.

We support digital building modeling by providing 3D models for climate ceilings (project-specific) and ventilation components using Revit BIM software.



Sustainability at Barcol-Air

Science Based Targets Initiative (SBTi)



The Swegon Group signed the Science Based Target Initiative (SBTi) in 2023. The goal is a 50% reduction in carbon emissions by 2030 compared to 2022. Together, we are focusing on innovative solutions to achieve this goal – including the use of carbon-reduced steel for climate ceilings.



Environmental Product Declarations

An Environmental Product Declaration (EPD) is an independently verified and registered document that gives transparent information about the environmental impacts of a product over its lifecycle.

At Swegon Group, sustainability is first and foremost the foundation of everything we do. This includes not only developing energy-efficient products and using sustainable materials, but also documenting and disclosing the environmental impact of each product.



Building mass connection with our hybrid systems

Energy efficiency is known as using less energy to get the same output. Free cooling is known as utilising the colder outdoor temperatures at night as a natural source for cooling, hence no necessity for the chiller to use additional energy. These two, energy efficiency and free cooling, are essential outcomes of using the potential of energy mass storage. Making use of a building mass to store energy during the night, makes it possible to take advantage of both while not making compromises with the indoor climate.

 You can find more information in our documents:

« Climate ceilings with mass connection »



Scan me

« Closed and wood-hybrid climate ceilings with building mass coupling »



Scan me



RYKO ceiling system

Our patented RYKO system enables the reuse of ceiling panels in ceiling sail systems, reducing waste and offering maximum flexibility for future modifications.

Conventional systems cannot meet these requirements, as their design necessitates panels with various bends and cut-outs. In contrast, our system allows any panel to be installed in any position. Ceiling sails can also be downsized at a later stage without the need to order new panels. Our innovation further enhances stability, simplifies installation, and ensures a consistently precise joint pattern. RYKO conserves resources and reduces the carbon footprint.



Play Video

Carbon-reduced steel for climate ceilings

A large proportion of a building's emissions are generated before it is used – through so-called grey energy. Especially when it comes to metal components such as climate ceilings, it is worth opting for materials with low grey energy. Carbon-reduced steel offers a clear benefit because it begins where the steel is produced, which so far has generated major carbon emissions.

- Grey energy - choice of materials is the key
- Conventional vs. carbon-reduced steel
- Shaping sustainability together

Physical principles

The principle and advantages of thermal radiation

People are sensitive not only to the air temperature, but thermal radiation too. Climate ceilings control the temperatures of surfaces in a room through the exchange of radiation, not via the air. This means that the air temperature can be set higher in cooling mode and does not need to be cooled to the extent required with conventional systems (for example, 26 °C rather than 23 °C). When heating, on the other hand, the room temperature can be set slightly lower without adversely affecting comfort (e.g. 20 °C rather than 23 °C). This results in high thermal comfort among room users, whilst simultaneously reducing the energy consumed by the system.

Ceiling response speed with climate cooling

When a climate ceiling is switched on, the effect is almost instantly discernible. Thermal radiation travels at the speed of light – in contrast to conventional systems, which have to control the temperature of all the air in the room.



You can find more information in our document « The Basic Principles of Climate Ceilings »



Scan me

Climate ceiling systems and their advantages

Climate ceiling systems offer a sustainable, flexible, and comfortable solution for indoor climate control. They not only reduce energy consumption but also ensure an optimal room climate. The well-being of employees plays a central role, as a pleasant indoor climate significantly contributes to performance and overall comfort.

High energy efficiency:

Climate ceilings are particularly energy efficient because they operate with moderate water temperatures. The flow temperatures can be set higher in cooling mode and slightly lower in heating mode, which reduces electricity consumption because less power is required to supply the water. By utilising the building mass as an energy store, it is possible to halt the load peaks. The stored energy is transported out of the building at night by means of “free cooling”, thereby allowing the refrigeration units to be sized more efficiently.

Healthier and more comfortable ambient air

- **No swirling dust:** Climate ceilings control the temperatures of surfaces in a room and do not generate strong air circulation. This means that less dust is stirred up – a decisive advantage for allergy sufferers and asthmatics.
- **Optimum humidity:** Climate ceilings do not affect the humidity in the room, resulting in a stable and pleasant room climate.
- **Low noise level:** Climate ceilings operate silently, because the air is not temperature controlled – instead, the energy transfer takes place through radiation.
- **No draughts:** The ventilation components of a climate ceiling satisfy all comfort criteria. In the occupied parts of the room, air speeds are always below the maximum level.



Image: © Mark Seelen

Sound absorption with climate ceilings

The ceiling is usually the largest clear surface in a room that can be used effectively for acoustic purposes. It is also horizontal and always relatively close to the source of the noise, which makes it ideal for absorbing sound from the room. Having taken over 200 sound absorption measurements, we can make highly substantiated statements about sound absorption with climate ceilings.

Room acoustics are an important element of any examination of indoor comfort. Various solutions are available in order to achieve optimum acoustic comfort. However, these are only helpful and effective if they take into account prevailing conditions, intended uses and scientific principles. It is particularly worthwhile to include the ceiling in the room acoustic concept. It should be ideally installed for sound absorption from a technical point of view, offer plenty of space and be capable of making a significant contribution to good room acoustics.

As a provider of climate ceiling systems specialising in indoor comfort, we regard room acoustics as a significant comfort factor. Corresponding parameters for the different climate ceiling systems are therefore available from certified test institutes for room acoustic planning.



You can find more information in our document « Room acoustics in offices »



Scan me

U4X Hybrid system

Hybrid system with building mass connection

The U4X hybrid system is a multifunctional climate ceiling system and is ideal for meeting the increasing demands of modern buildings. A special feature of the U4X is inclusion of the building mass through direct control of the concrete ceiling. This results in a mass storage capacity in addition to the usual water and air cooling capacity. This can significantly reduce operating costs and CO₂ emissions.

Thanks to its closed room design, the U4X hybrid system delivers good sound absorption values, particularly in the low frequency range.

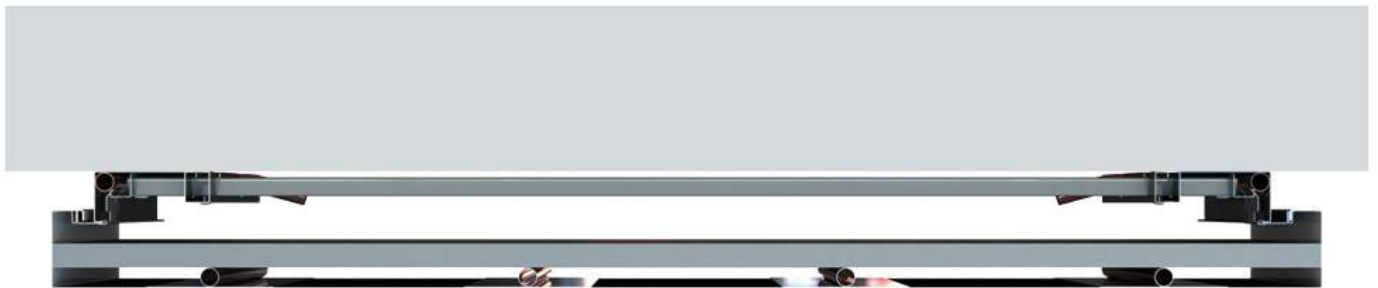

Delivering enhanced wellbeing

The U4X climate ceiling system is particularly suitable for offices, conference rooms, hotels, schools and other commercial applications.

It not only ensures comfort, but also promotes productivity and the wellbeing of employees and customers.

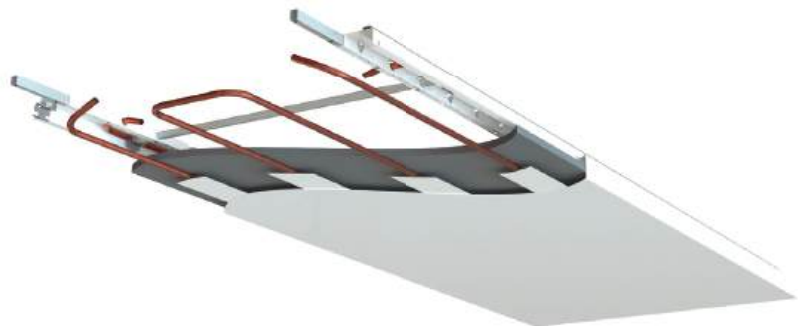



- ✓ Offices and commercial buildings
- ✓ Educational institutions
- ✓ Medical facilities
- ✓ Museums / theatres / cinemas

FAVO Hybrid system

Hybrid system with building mass connection

Thanks to its comprehensive functionality, the hybrid system FAVO plus the A11-S or SPECTRA M-S heating & cooling sails achieves an optimum room climate in any environment. It has very high cooling and heating capacities, a comfortable air supply and superior acoustic properties. According to the principle of the thermoactive component system, it also includes the storage mass for the dissipation of heat loads in the overall room thermal concept. This reduces energy requirements and operating costs.



Optional added performance: FAVO + Convector Wings

A further increase in performance can be achieved with the Convector Wings developed and patented by Barcol-Air.

Convector Wings are matt black anodised aluminium profiles with upright and slotted "wings" on both sides. With the profile open at the bottom, the Convector Wings can be attached to the straight sections of a pipe meander. This multiplies the heat exchanger surface area, which in turn leads to an increase of capacity on the water side.

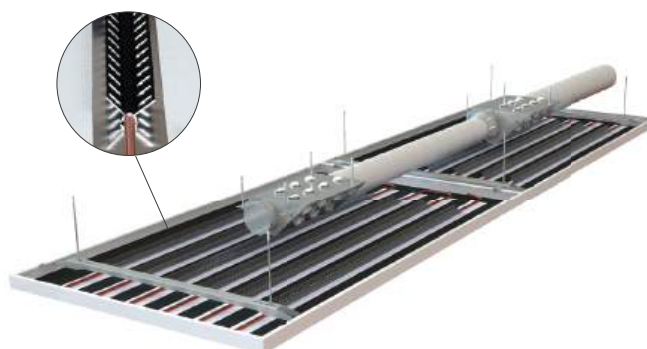

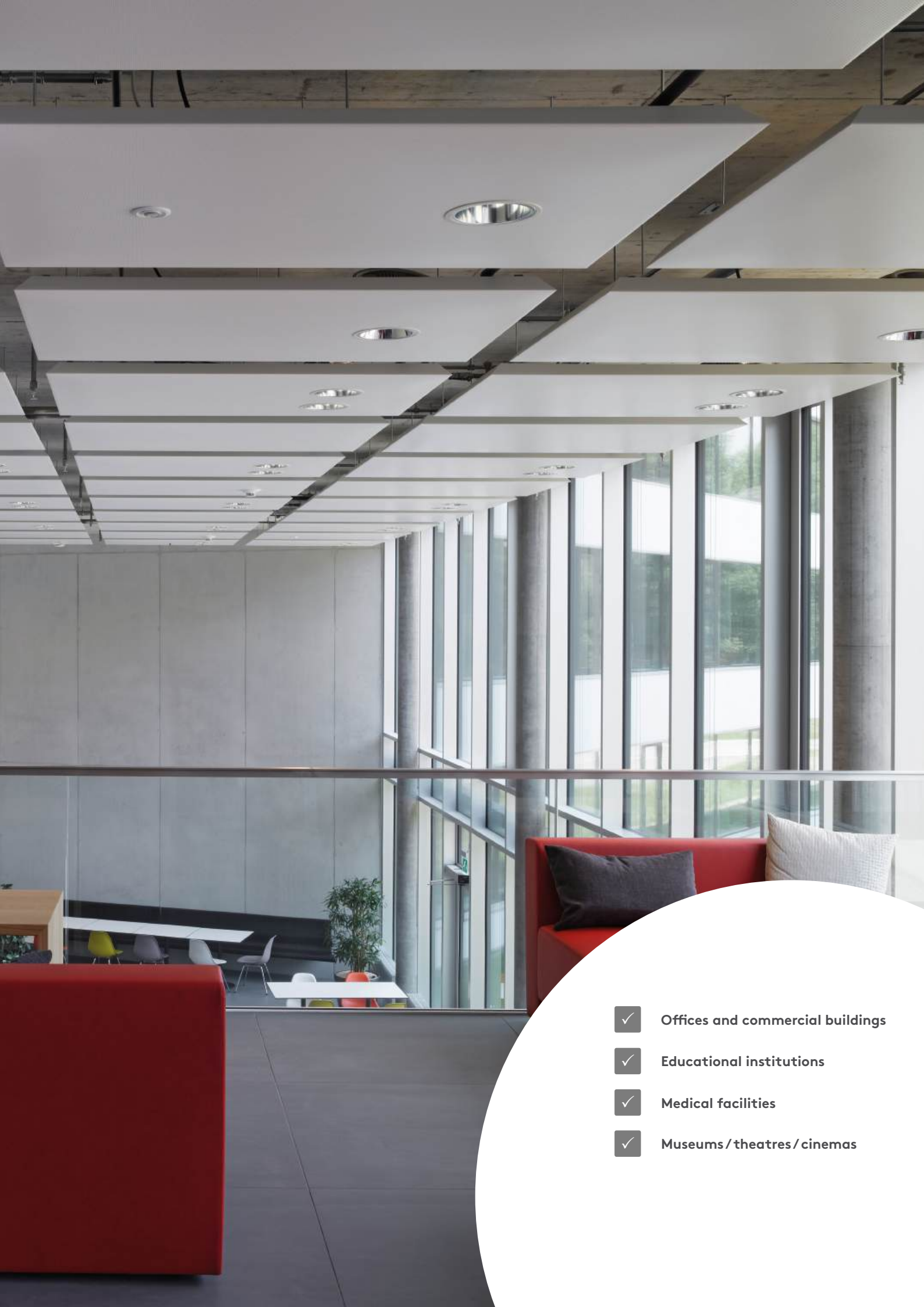

- ✓ Offices and commercial buildings
- ✓ Educational institutions
- ✓ Medical facilities
- ✓ Museums / theatres / cinemas

CAURUS Hybrid system

Hybrid system with building mass connection

Thanks to its comprehensive functionality, the CAURUS hybrid system with the A11-S or SPECTRA M-S climate ceiling sails achieves an optimum room climate in any environment. This combination has very high heating and cooling capacities, convenient supply air ducting and very good acoustic properties.

Using the thermally active building system principle, this climate ceiling system incorporates the storage mass for dissipating heating loads into the overall room thermal concept. This can significantly reduce operating costs and CO₂ emissions.

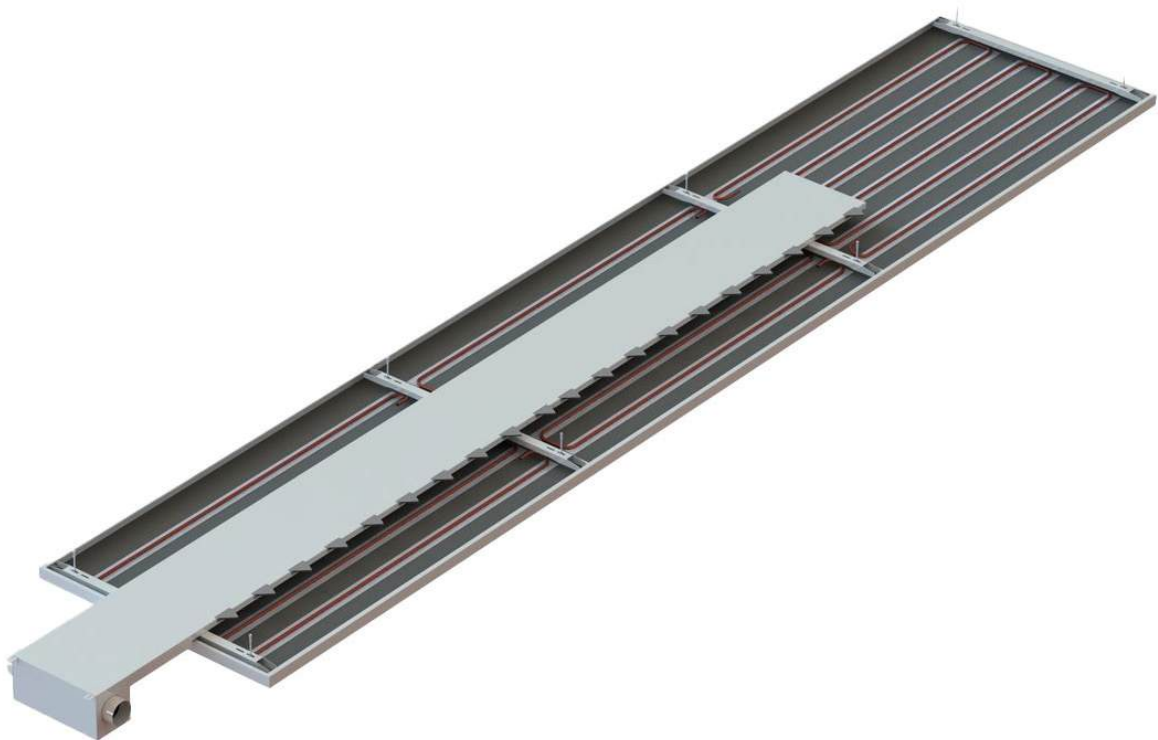

Optional added performance: CAURUS + Convector Wings

A further increase in performance can be achieved with the Convector Wings developed and patented by Barcol-Air.

Convector Wings are matt black anodised aluminium profiles with upright and slotted "wings" on both sides. With the profile open at the bottom, the Convector Wings can be attached to the straight sections of a pipe meander. This multiplies the heat exchanger surface area, which in turn leads to an increase of capacity on the water side.



- ✓ Offices and commercial buildings
- ✓ Educational institutions
- ✓ Medical facilities
- ✓ Museums / theatres / cinemas

AQUILO Hybrid system

Hybrid system with building mass connection

AQUILO + the A11 or SPECTRA M climate ceiling system are highly efficient climate ceiling systems with integrated supply air and superior acoustic effectiveness. The AQUILO hybrid system delivers highly effective ventilation results. At the same time, the supply air jet on the back of the ceiling panel increases the convective capacity, which supports the heating and cooling effect in the room without a risk of draughts.

The AQUILO hybrid system with A11-C and SPECTRA M-C ceilings incorporates the storage mass for dissipating heating loads using the thermally active building system principle.

The A11-S sail allows the use of our specially developed Convector Wings to increase performance.

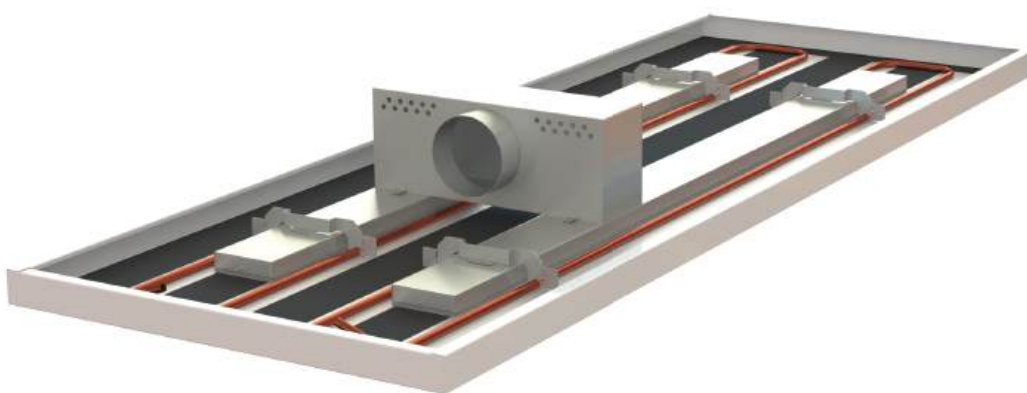

3-channel type AQUILO with supply air flow characteristics.

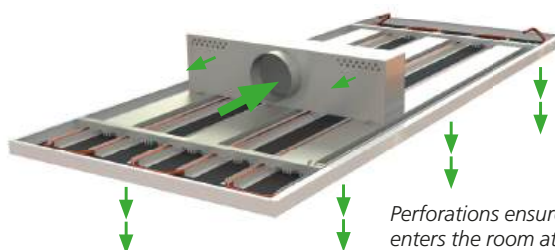

Perforations ensure that the supply air enters the room at low velocity

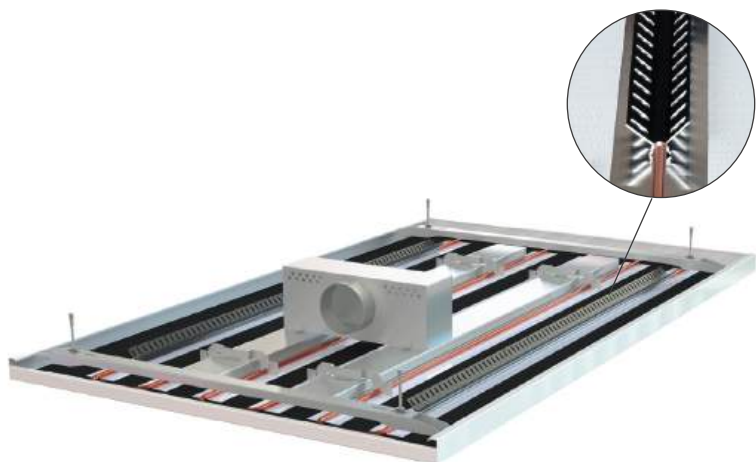

Activated A11-S ceiling panels are suitable for use with Convector Wings.

Optional added performance: AQUILO + Convector Wings

Convector Wings are matt black anodised aluminium profiles with upright and slotted "wings" on both sides. With the profile open at the bottom, the Convector Wings can be attached to the straight sections of a pipe meander. This multiplies the heat exchanger surface area, which in turn leads to an increase of capacity on the water side.



- ✓ Offices and commercial buildings
- ✓ Educational institutions
- ✓ Medical facilities

VENTAMIC Hybrid system

Hybrid system with building mass connection

VENTAMIC + the climate metal ceiling A11-C or SPECTRA M-C are highly efficient ceiling system with integrated supply air and superior acoustic effectiveness. The VENTAMIC hybrid system delivers highly effective ventilation results. The air speed in occupied areas remains extremely low thanks to the Coanda effect.

The supply air jet generates negative pressure in the ceiling cavity, which increases the convective capacity and significantly heightens the heating and cooling effect of the water-based climate ceiling. Furthermore, this system uses the building mass to store energy temporarily. With this function, the heat-load peaks can be broken down. The system works according to the principle of thermally active building systems.

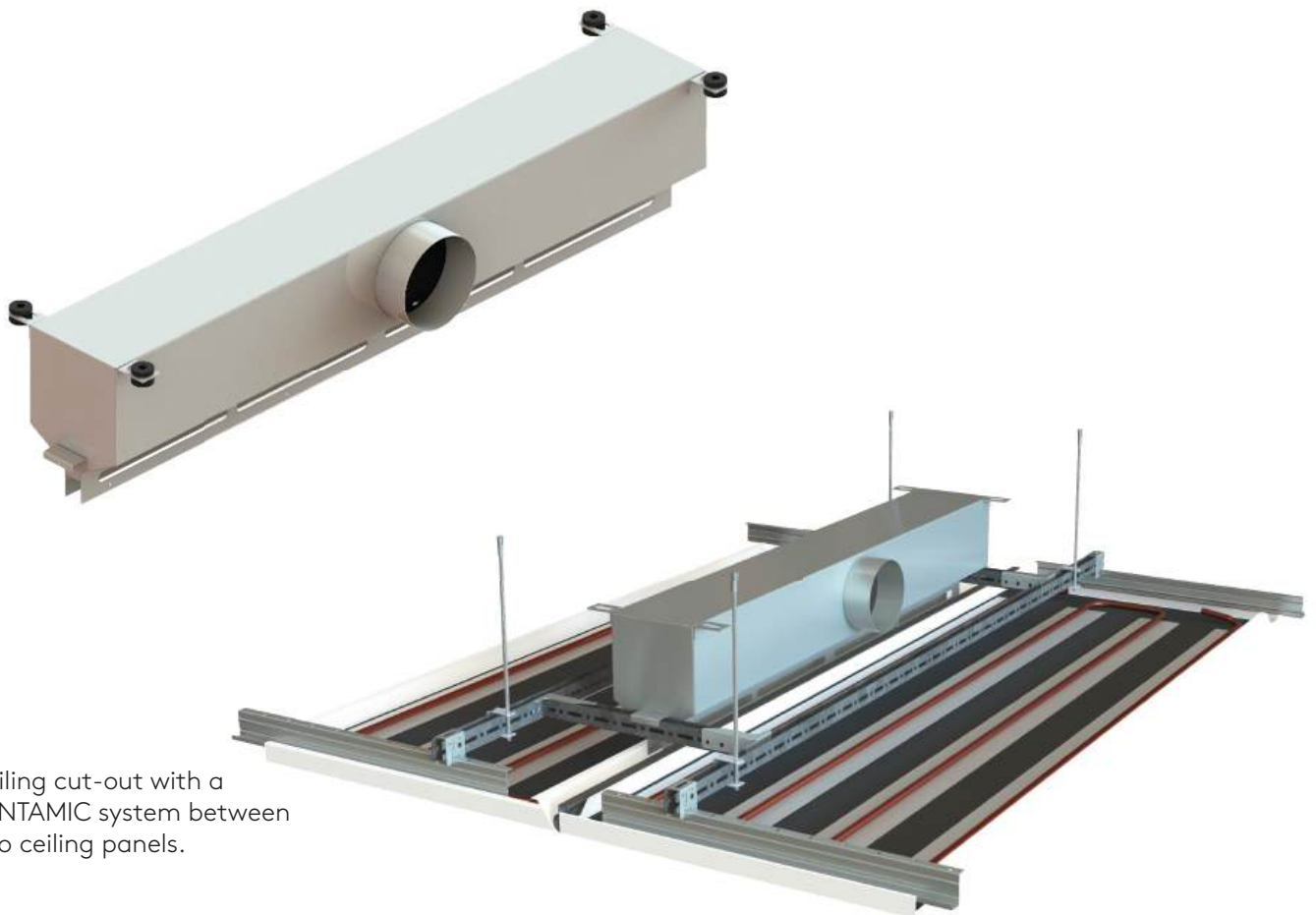

Ceiling cut-out with a VENTAMIC system between two ceiling panels.

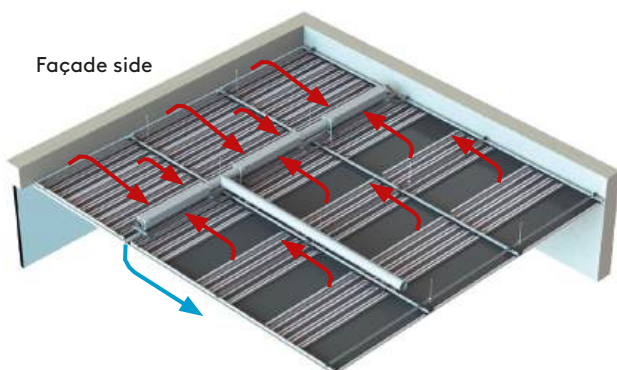

Flow characteristics of the supply air

The supply air jet generates negative pressure in the ceiling cavity, which draws warm air from the room through the joints on the façade side and between the ceiling panels, and returns it to the room cooled by the recirculation effect.

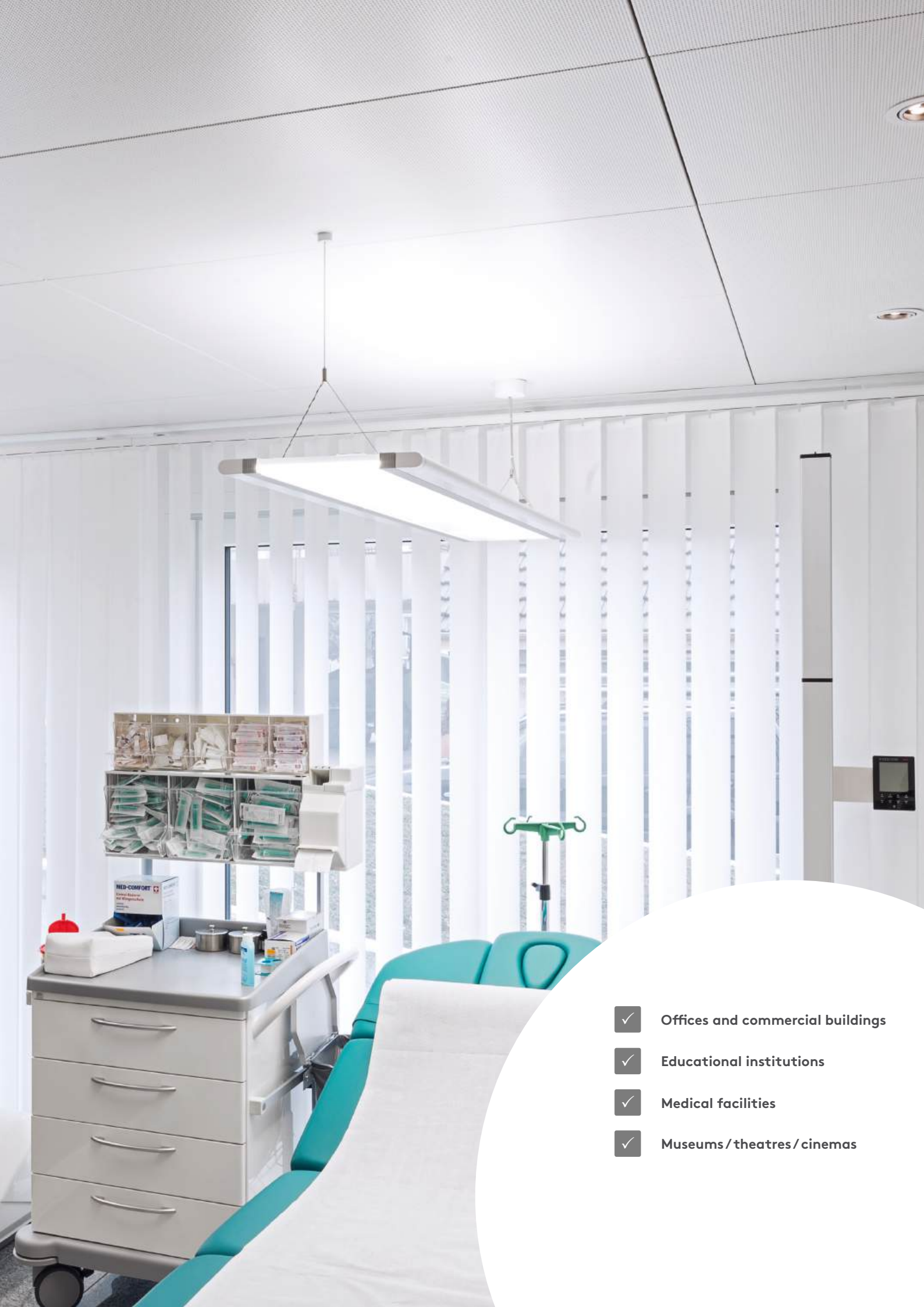

- ✓ Offices and commercial buildings
- ✓ Educational institutions
- ✓ Medical facilities
- ✓ Museums / theatres / cinemas

A11-S Climate ceiling sail

The slimline high performance sail

The A11-S climate ceiling sail is a highly efficient climate ceiling system that receives a flow of room air on all sides. If a full-surface insulation insert is not installed, the back of the sail can also actively contribute to room cooling.

The innovative A11 activation system has a special structure. The copper pipe and aluminium heat conducting rails are welded together using laser technology. The coils are permanently bonded to the metal plates using a special adhesive and high pressure, thereby ensuring optimum thermal transfer. Aluminium panels can also be activated using the adhesive technology, which results in further improvements in performance.

In order to satisfy the acoustic requirements, acoustic fleece is bonded in the back of the ceiling panels. In particularly sensitive areas, additional insulation strips can be inserted at the side of the coil to increase sound absorption without reducing the cooling capacity.

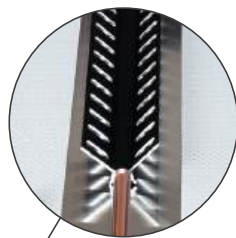
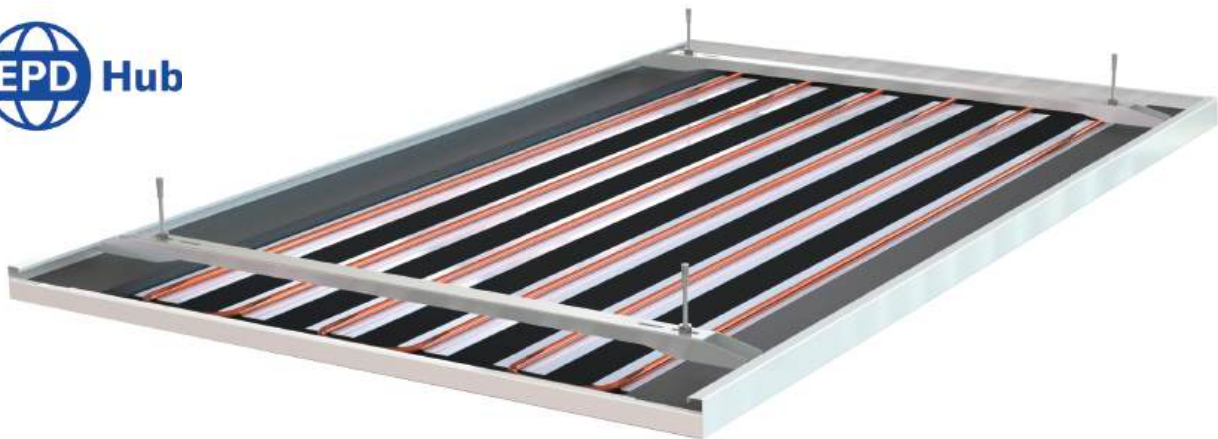

Optional added performance: A11-S + Convector Wings

A further increase in performance can be achieved with the Convector Wings developed and patented by Barcol-Air.

Convector Wings are matt black anodised aluminium profiles with upright and slotted "wings" on both sides. With the profile open at the bottom, the Convector Wings can be attached to the straight sections of a pipe meander. This multiplies the heat exchanger surface area, which in turn leads to an increase of capacity on the water side.



- ✓ **Offices and commercial buildings**
- ✓ **Educational institutions**
- ✓ **Medical facilities**
- ✓ **Museums / theatres / cinemas**

SPECTRA M-S Climate ceiling sail

A unique climate ceiling system with magnetic force

The SPECTRA M-S climate sail is a highly efficient climate ceiling system with superior acoustic effectiveness. The magnetic connection of the activation coil and ceiling panel allows both components to be prefabricated concurrently and delivered separately to the construction site for assembly there.

The SPECTRA M coil is ideal for refurbishing buildings in which existing metal ceilings are to be activated at a later stage. Furthermore, the coils can be fitted and hydraulically connected independently of the ceiling panels, meaning that the cooling technology can be installed and commissioned before the surface is finished. This also enables operation of the coils in advance for construction heating.

In order to satisfy the acoustic requirements, acoustic fleece is bonded in the back of the ceiling panels. In particularly sensitive areas, additional insulation strips can be inserted at the side of the coil to increase sound absorption without reducing the cooling capacity.

The design of the SPECTRA M coil also makes it possible to separate all components by material type for subsequent feeding into a recycling process. This contributes to a sustainable circular economy even after the useful life of the product has come to an end.

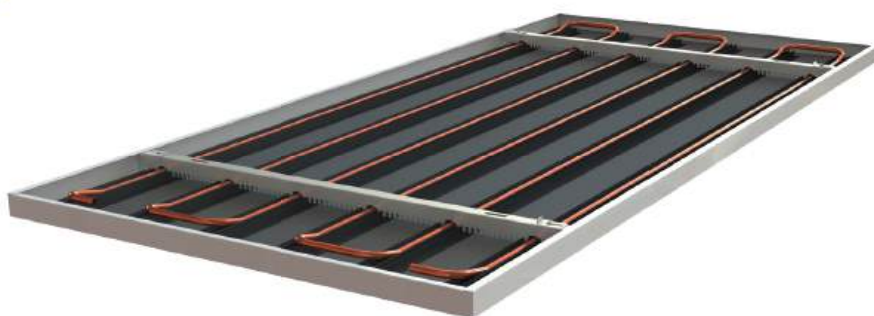

Impressive magnet technology

A further advantage of the system is that the magnet technology and U support rails used to secure the activation coils in place prevent the panels from sagging, even with larger panel formats.





- ✓ Offices and commercial buildings
- ✓ Educational institutions
- ✓ Medical facilities
- ✓ Museums / theatres / cinemas

VARICOOL TKM Climate textile ceiling sail*

Sustainability meets design: This textile ceiling sail is an innovative solution for modern architecture

The VARICOOL TKM climate textile ceiling sail is a water-based climate ceiling system. In conjunction with the CAURUS hybrid system, it guarantees an optimum room climate in any environment. This combination has very high heating and cooling capacities, convenient supply air ducting and superior acoustic properties. In addition, the system incorporates the storage mass for dissipating heat loads into the overall room thermal concept using the thermally active building system principle. This further reduces energy requirements and operating costs.

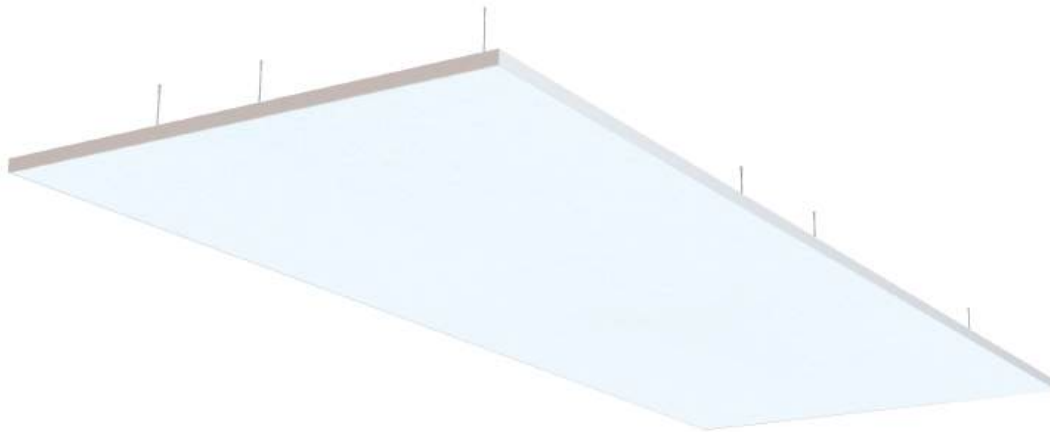

Efficient indoor air circulation with CAURUS

With supply air flow rates of up to $35 \text{ m}^3/\text{h} \cdot \text{linear metre}$ per sail, the supply air is introduced horizontally into the room on one side above the textile sail. Specially developed high capacity induction nozzles draw in warm room air on the opposite side of the sail and accelerate it via the supply air channel, thus achieving high energy transfer into the concrete. The energy temporarily stored in this way can be dissipated at night – with free cooling if possible. Due to the highly effective ventilation results, draught-free mixing of the air throughout the room with a homogeneous temperature profile is established within a very short time.

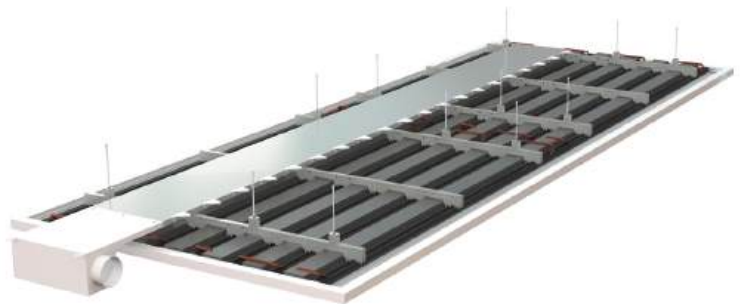

*Currently only available in Switzerland



- ✓ Offices and commercial buildings
- ✓ Educational institutions
- ✓ Medical facilities
- ✓ Museums / theatres / cinemas

AKUSTIKTHERM Climate ceiling sail

For thermally active building systems (TABS)

AKUSTIKTHERM is an acoustically effective and thermally conductive ceiling sail system for use in properties with thermally active building systems (TABS). The acoustic sail transfers energy from the concrete surface into the room via heat radiation using an exchange system with a special coating, while at the same time providing expansive sound absorption surfaces.

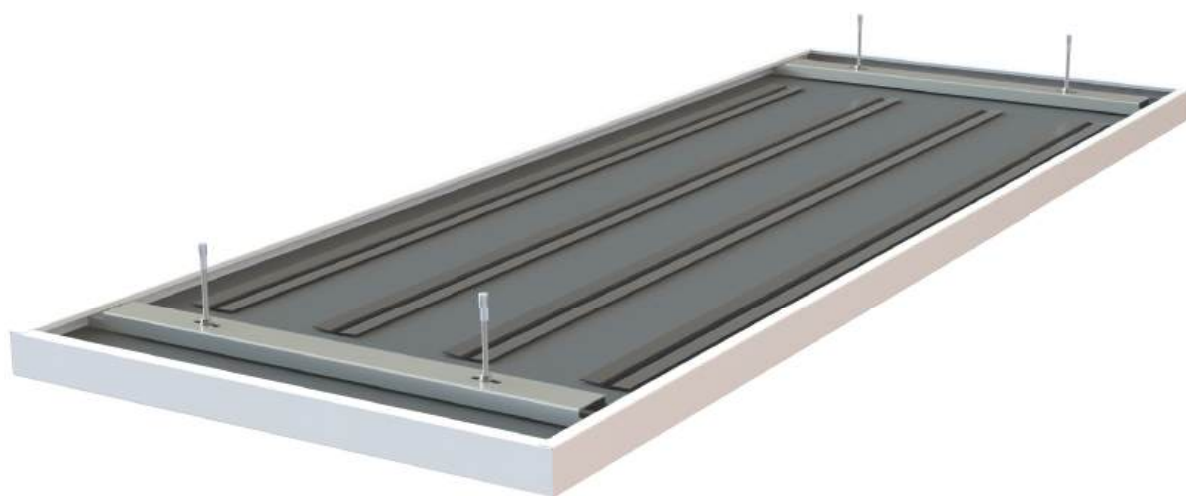

If you wish to improve the acoustics in an open-plan office, event room or restaurant, AKUSTIKTHERM is the ideal solution for creating a pleasant acoustic environment and increasing the productivity and satisfaction of your employees, customers or guests.



- ✓ Offices and commercial buildings
- ✓ Educational institutions
- ✓ Medical facilities
- ✓ Museums / theatres / cinemas

A11-C Climate ceiling

Discreet yet striking climate ceiling

The A11-C climate metal ceiling delivers high thermal comfort in rooms with large heating loads, without causing draughts. The climate ceiling system also exhibits advanced acoustic effectiveness.

The innovative A11 activation system has a special structure. The copper pipe and aluminium heat conducting rails are joined together using laser welding technology. The coils are permanently bonded to the metal plates by a special adhesive and high pressure, thereby ensuring optimum thermal transfer. Aluminium panels can also be activated using the adhesive technology, which results in further improvements in performance.

In particularly sensitive areas, additional insulation strips can be inserted to increase sound absorption without reducing the cooling capacity. A full-surface insulation layer is also possible.

The versatility of the product means that all standard installation methods and special solutions that are typical for metal ceilings can be used. This includes options such as C-Channel-, Hook-On- or Clip-In ceiling systems, which makes it easy to adapt to different room designs and architectural specifications.

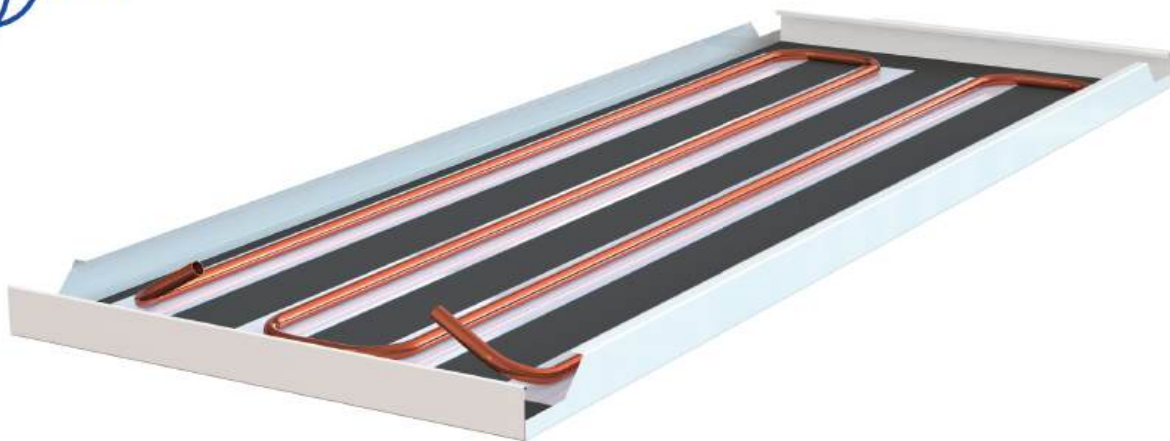



- ✓ Offices and commercial buildings
- ✓ Educational institutions
- ✓ Medical facilities
- ✓ Museums / theatres / cinemas

SPECTRA M-C Climate ceiling

A unique climate ceiling system with magnetic force

The SPECTRA M-C climate ceiling is a water-based climate ceiling system with high thermal and advanced acoustic effectiveness. The magnetic connection of the activation coil and ceiling panel allows both components to be prefabricated concurrently and delivered separately to the construction site for assembly there. As a result, the manufacturing time for the ceiling as a whole is significantly reduced.

The SPECTRA M coil is ideal for refurbishing buildings in which existing metal ceilings are to be activated at a later stage. Furthermore, the coils can be fitted and hydraulically connected independently of the ceiling panels, meaning that the cooling technology can be installed and commissioned before the surface is finished. This also enables operation of the coils in advance for structural heating.

In particularly sensitive areas, additional insulation strips can be inserted to increase sound absorption without reducing the cooling capacity. A full-surface insulation layer is also possible.

The design of the SPECTRA M coil also makes it possible to separate all components by material type for subsequent feeding into a recycling process. This contributes to a sustainable circular economy even after the useful life of the product has come to an end.



Impressive magnet technology

A further advantage of the system is that the magnet technology and U support rails used to secure the activation coils in place prevent the panels from sagging, even with larger panel formats.



- ✓ Offices and commercial buildings
- ✓ Educational institutions
- ✓ Medical facilities
- ✓ Museums / theatres / cinemas

ECO M-C Climate ceiling

A flexible climate ceiling system with magnetic force

ECO M-C is a water-based radiant ceiling system in which the heating/cooling coil is securely attached to the ceiling panels by an innovative magnetic connection. The system works predominantly according to the radiation principle, which offers high thermal comfort, optimum energy efficiency and a pleasant, draught-free indoor climate.

In addition, room acoustics are good due to a specially developed acoustic fleece that is glued into the perforated ceiling panel. With indirect lighting via the reflective ceiling surface, glare-free illumination of the room can be achieved.

This radiant ceiling system is characterised by a wide range of application and design options. It is primarily used in office and administration buildings, shops, training/conference facilities and hospital treatment rooms.



Impressive magnet technology

A further advantage of this system is, that heating and cooling registers can be mantled and dismantled without destroying the panel. Retrofitting an inactive ceiling panel is easy to do.



- ✓ Offices and commercial buildings
- ✓ Educational institutions
- ✓ Medical facilities
- ✓ Museums / theatres / cinemas

VARICOOL UNI Climate ceiling

Thermally active plasterboard ceiling

The jointless VARICOOL UNI climate ceiling is suitable for properties in which a combination of aesthetics and thermal comfort is required. It is visually indistinguishable from a conventional drywall ceiling. Full-surface ceiling activation, installations and customised ceiling designs with 3D elements are all possible with this solution. VARICOOL UNI can also be used as a sail.

Perforated plasterboard panels with acoustic fleece applied to the back can be used to satisfy the acoustic requirements. An additional insulation layer can be provided in order to increase sound absorption in particularly sensitive areas.

The heating/cooling coils are adapted to the standard substructure and replace parts of it. The system is suitable for use with plasterboard, expanded glass granulate and aluminium honeycomb panels.

Optimum heat transfer

The panelling is bolted directly to the activation profiles. This ensures very good heat transfer and consistent quality.





- ✓ Offices and commercial buildings
- ✓ Educational institutions
- ✓ Medical facilities
- ✓ Museums / theatres / cinemas

VARICOOL AP Climate ceiling

Thermally active plasterboard ceiling

The jointless VARICOOL AP climate ceiling is suitable for properties in which a combination of aesthetics and thermal comfort is required. It is visually indistinguishable from a conventional drywall ceiling. Full-surface ceiling activation, the flexible arrangements of profiles, installations and customised ceiling designs with 3D elements are all possible with this solution. VARICOOL AP can also be used as a sail.

Perforated plasterboard panels with acoustic fleece applied to the back can be used to satisfy the acoustic requirements. An additional insulation layer can be provided in order to increase sound absorption in particularly sensitive areas.

The activation profiles for jointless climate ceilings are adapted to the standard substructure and replace parts of it. The system is suitable for use with plasterboard, expanded glass granulate and aluminium honeycomb panels.



Optimum heat transfer

The panelling is bolted directly to the activation profiles. This ensures very good heat transfer and consistent quality.

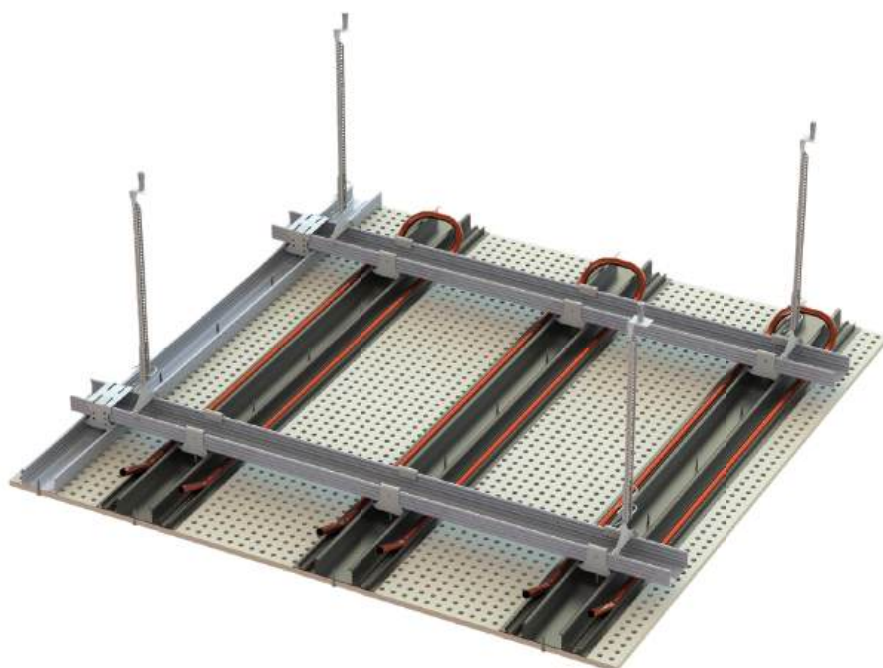



- ✓ Offices and commercial buildings
- ✓ Educational institutions
- ✓ Medical facilities
- ✓ Museums / theatres / cinemas

ARCHISONIC® Acoustic baffle

Unique room ambience with stylish design

ARCHISONIC® + the A11 climate metal ceiling system or ALBATROS high performance module are visually and functionally impressive in equal measure. The system satisfies the requirements of a modern climate ceiling when it comes to both energy efficiency and performance. The combination of the climate ceiling system with the ARCHISONIC® acoustic baffle from Impact Acoustic® also forms a highly effective sound absorber across the entire frequency spectrum.

Whilst the felt panels (made from recycled PET bottles) primarily absorb sound in the high frequency range, the strength of the A11 climate metal ceiling system lies in the low frequency range.

The combination solution can be used as an A11-C closed climate ceiling system, A11-S sail or ALBATROS high performance module. The acoustic baffles are available in a wide range of colours and in the versions Straight, Wave or Edge. They are installed on site on the underside of the metal ceiling using a simple suspension method.

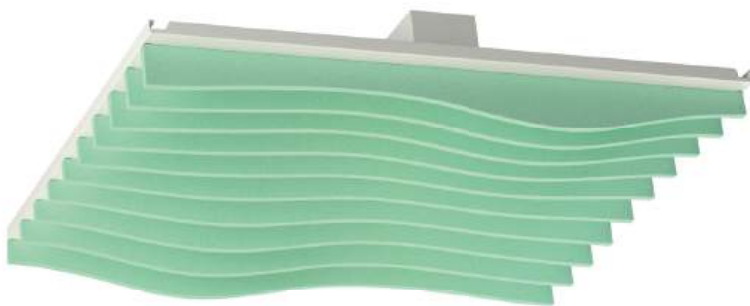

ARCHISONIC® Wave

ARCHISONIC® Straight

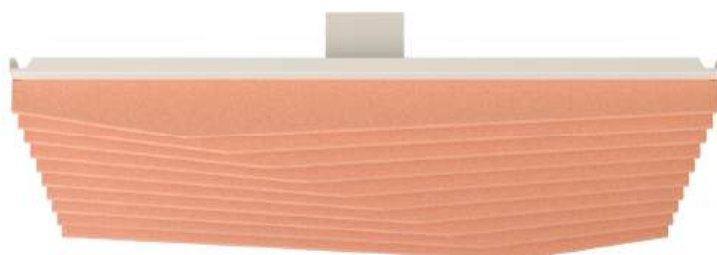
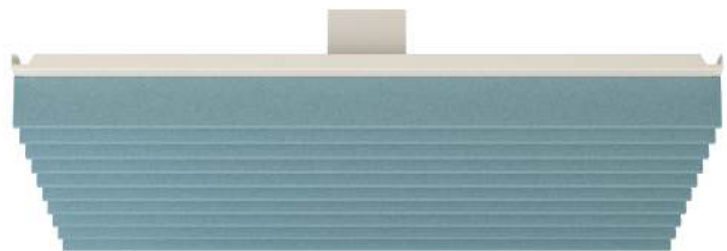

ARCHISONIC® Edge



- ✓ Offices and commercial buildings
- ✓ Museums / theatres / cinemas
- ✓ Restaurants and cafeterias

ALBATROS High performance module

High performance module for unbeatable cooling capacity

The ALBATROS high performance module is a climate ceiling system for rooms with a high cooling demand. It achieves a very high thermal performance with its slotted aluminium fins in the shape of a wing.

Through optional combination with the sound absorber structure, the ALBATROS also demonstrates advanced acoustic effectiveness.

Another special feature is the high surface-related, predominantly convective cooling capacity. Combination with any air ducting system is also possible. The modular ceiling system is suitable for covering the heating demand as well.

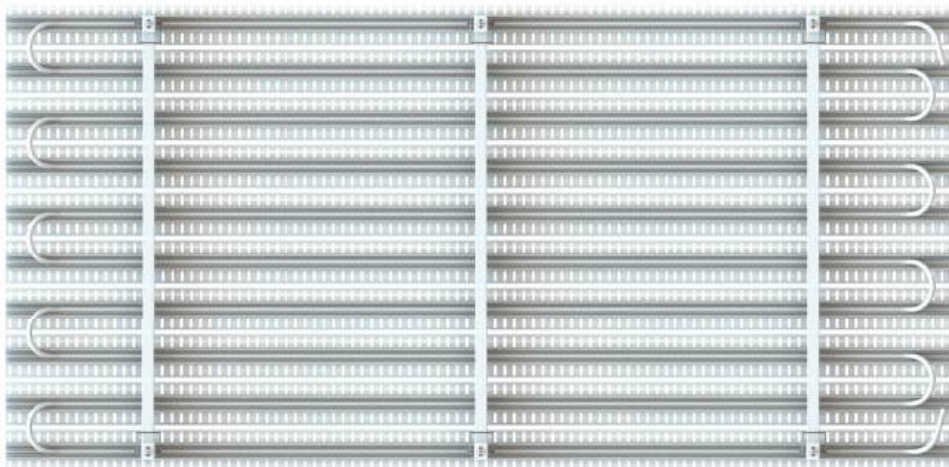
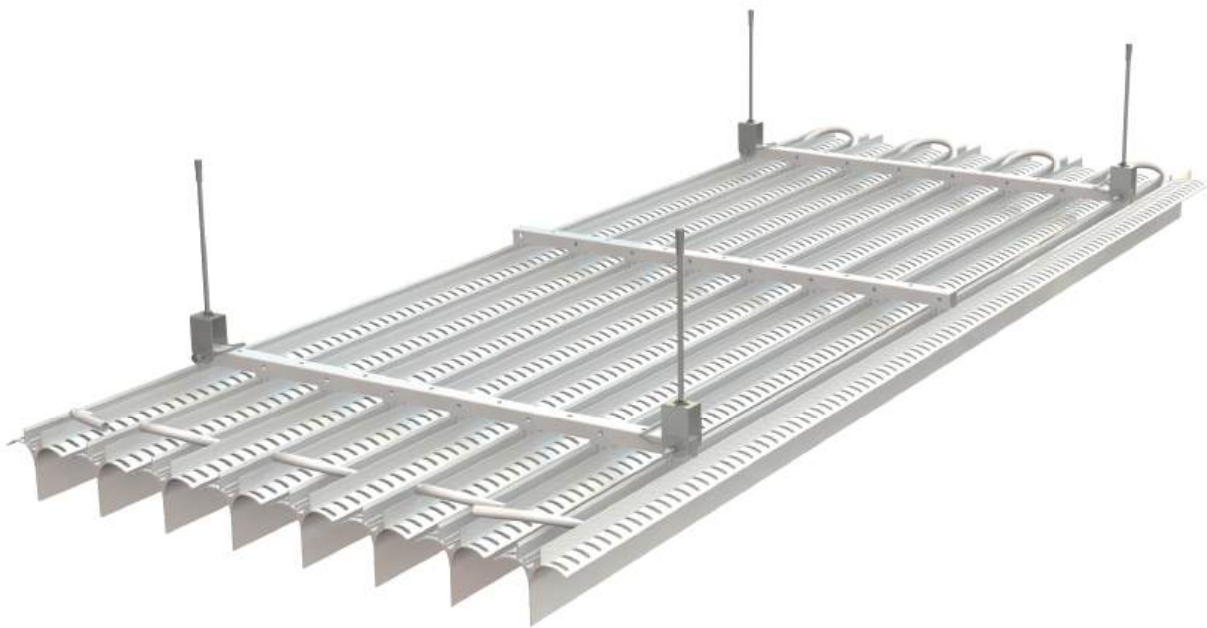



- ✓ Offices and commercial buildings
- ✓ Educational institutions
- ✓ Railway stations and airports
- ✓ Museums / theatres / cinemas

OPTI Y High performance module

High performance module with very high thermal capacity

OPTI Y is a high capacity cooling system with an open design for cooling rooms, predominantly through free convection and radiation. Equipped with a fine corrugated surface, the finned cooling elements are suitable for rooms of all types and can be used as individually suspended ceiling modules, a flat finned ceiling or in a concealed installation above a grid ceiling.

The high cooling capacity per unit area (mainly convective) and the large open ceiling cross-section are particular features. Sprinklers, smoke detectors, air diffusers, lighting fixtures, etc. can be installed between the fins.

It can be combined with any air ducting system. The OPTI Y high performance module can also cover the heating load.

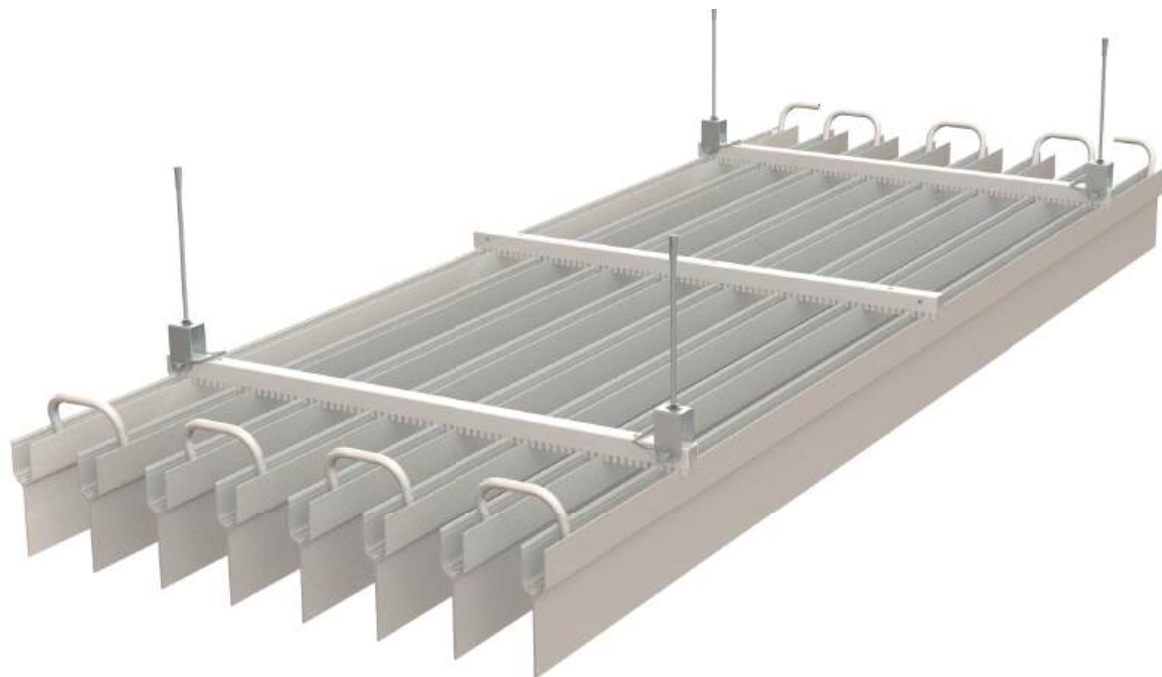

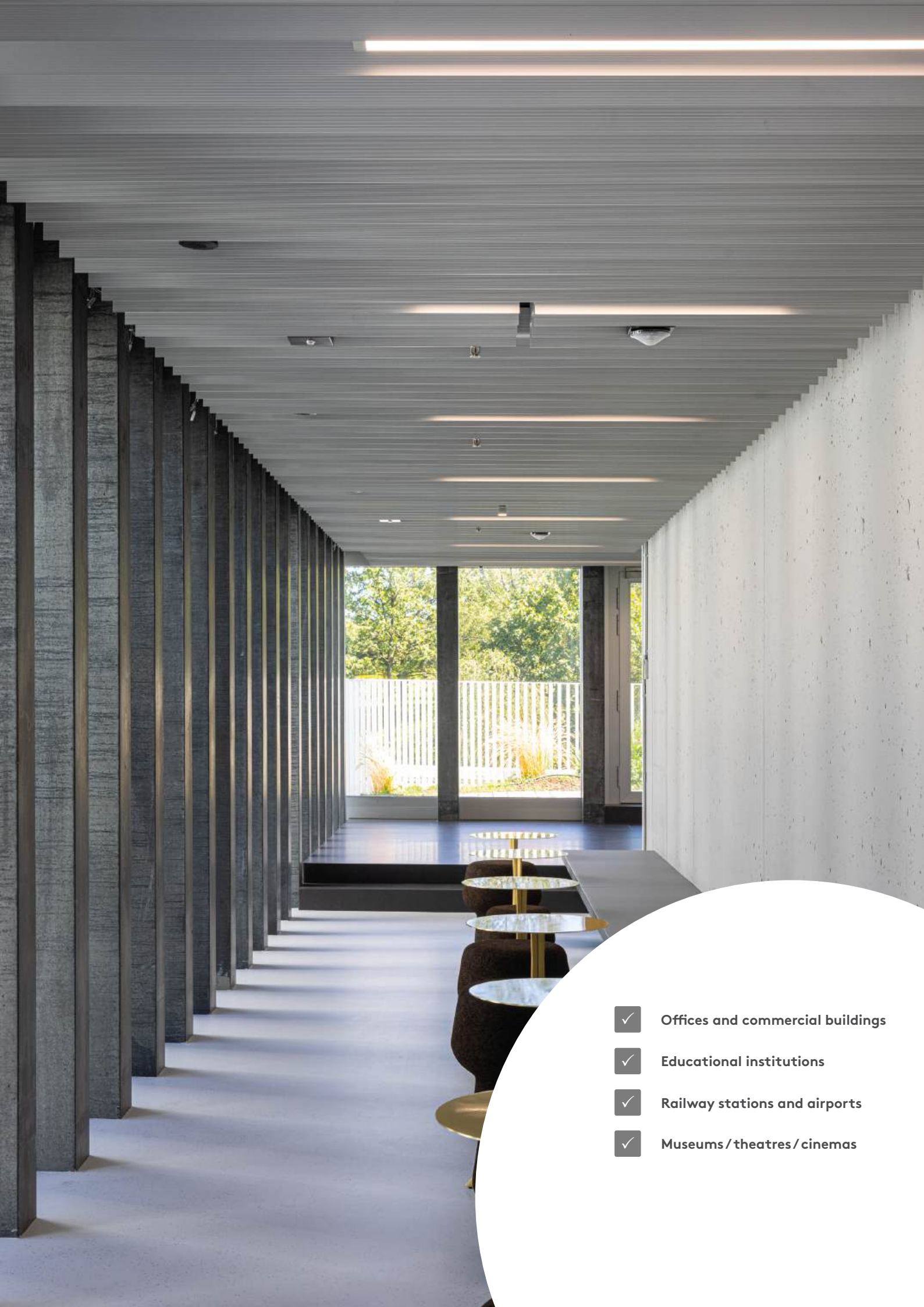

- ✓ Offices and commercial buildings
- ✓ Educational institutions
- ✓ Railway stations and airports
- ✓ Museums / theatres / cinemas

SOFTLINE High performance module

Aesthetic ceiling with high cooling capacity

SOFTLINE affords a wide range of installation options. With its sleek design, the ceiling fits perfectly in showrooms, offices and corridors. Lighting can be installed between the aluminium profiles or beneath the profiles in the form of pendant lights.

The SOFTLINE high performance modules are available as Base, Roof and Curve versions and offer maximum flexibility to adapt to different architectural and aesthetic requirements.



SOFTLINE Base



SOFTLINE Roof



SOFTLINE Curve



- ✓ Offices and commercial buildings
- ✓ Educational institutions
- ✓ Railway stations and airports
- ✓ Museums / theatres / cinemas

SOFTLINE WOOD

High performance module

Climate ceiling system with real wood

The high-performance module SOFTLINE WOOD is a climate ceiling system that combines the natural aesthetics of real wood with high-performance heat conducting profiles to create an optimum indoor climate.

The real wood slats are not only visually appealing, but also acoustically active, ensuring pleasant room acoustics. The high-performance heat-conducting profiles are circulated by the room air and enable efficient climate control - both for heating and cooling.



Wide selection of real wood slats for individual room concepts

The real wood slats are available in various wood types, colors, and finishes offering maximum design freedom and natural aesthetics. The modules are easy to install, can be combined with built-in elements, and can be extended with the CAURUS hybrid system.



- ✓ Offices and commercial buildings
- ✓ Educational institutions
- ✓ Railway stations and airports
- ✓ Museums / theatres / cinemas

METAL LINE Climate Baffle

Efficient and flexible high performance module

The METAL LINE climate baffles are an efficient climate ceiling system with good sound absorption properties. The vertical arrangement results in a comparatively high proportion of surface area with thermally and acoustically effective metal baffles.

Furthermore, the quick and easy installation means retrofitting in existing buildings is straightforward and does not affect ongoing use. The METAL LINE climate fins therefore offer an efficient, flexible and elegant solution for a pleasant room climate and an improved room acoustic concept.

In order to satisfy the acoustic requirements, acoustic fleece is bonded inside the climate fins. An additional insulation insert can be provided in order to increase sound absorption in particularly sensitive areas.

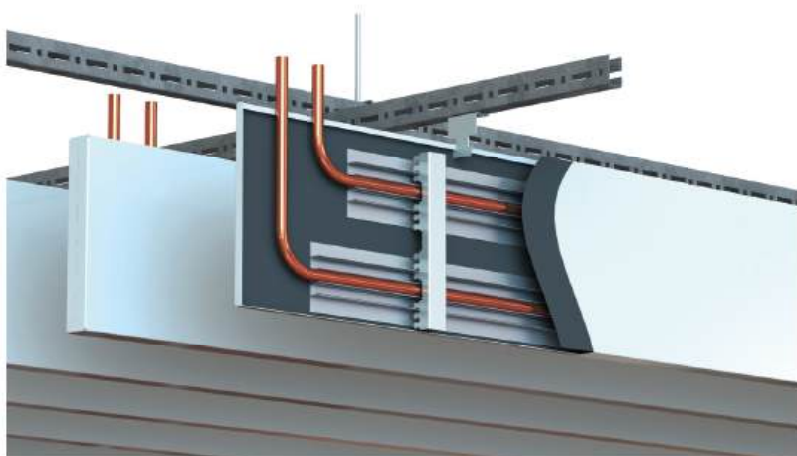
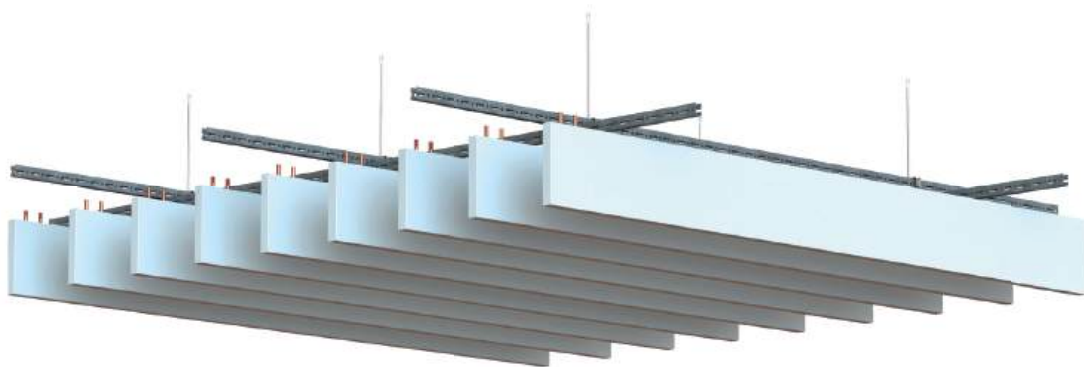

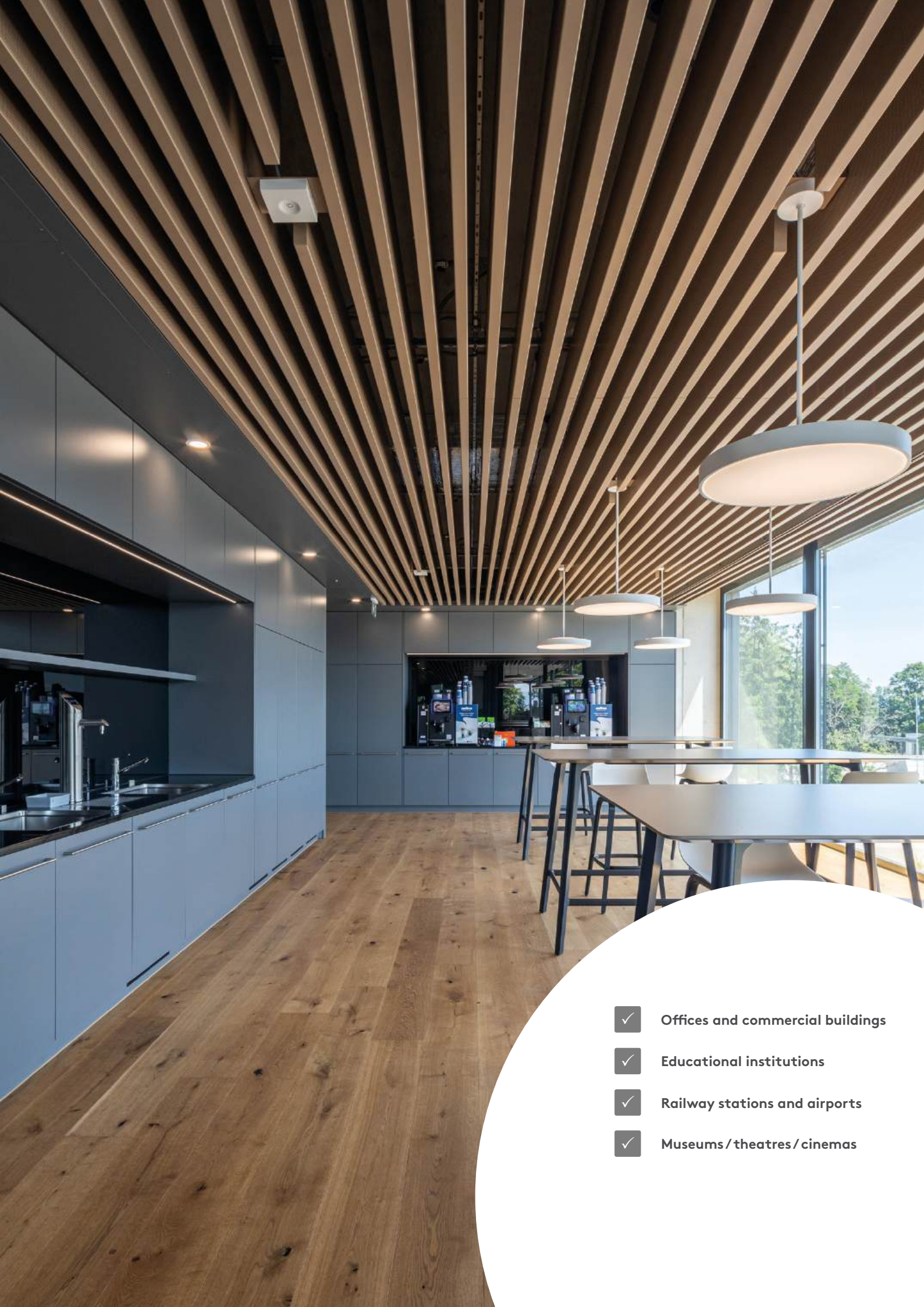

- ✓ Offices and commercial buildings
- ✓ Educational institutions
- ✓ Railway stations and airports
- ✓ Museums / theatres / cinemas

U4X

Hybrid system with building mass connection

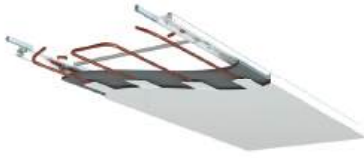

- Very high heating & cooling capacity
- Superior sound absorption values (class A)
- Lower energy consumption thanks to active building mass connection
- Covers cooling requirements with free cooling 75-85 % of the time
- Components can be integrated

Dimensions:

Installation height: 75 mm

- Panel length: 800 – 3000 mm
- Panel width: 400 – 1200 mm
- Panel height: 50 – 100 mm

Custom dimensions on request

Water capacity: *

Mass storage capacity:
up to 25 W/m² panel area

Cooling: up to 87 W/m² (ΔT: 8 K)
at 85 % Aar

Heating: up to 103 W/m² (ΔT: 15 K)



FAVO

Hybrid system with building mass connection



- In combination with A11-S, SPECTRA M-S
- Very high heating & cooling capacity
- Superior sound absorption values (class A)
- Enhanced energy efficiency thanks to active building mass connection
- Sound power level Lw: < 30 dB (A)
- Fresh air intake is silent and draught-free
- Connection to conventional ventilation ducts

Dimensions:

Installation height: min 205 mm

- Panel length: 800 – 3000 mm
- Panel width: 400 – 1200 mm
- Panel height: 30 – 50 mm

Custom dimensions on request

Water capacity: *

Mass storage capacity:
up to 20 W/m² panel area

A11-S, SPECTRA M-S
Cooling: up to 120 W/m² (ΔT: 8 K)
at 85 % Aar

Heating: up to 117 W/m² (ΔT: 15 K)

With flowing supply air, there will be a 20 to 40 % higher heating capacity.



CAURUS

Hybrid system with building mass connection



- In combination with A11-S, SPECTRA M-S, VARICOOL TKM, SOFTLINE WOOD
- Very high heating & cooling capacity
- Superior sound absorption values (class A)
- Building mass connection
- Integrated cross-talk sound attenuation (option)
- Low structural height
- Sound power level Lw: < 30 dB (A)
- Fresh air intake is silent and draught-free

Dimensions:

Installation height: 80 – 200 mm

- Panel length: 800 – 3000 mm
- Panel width: 400 – 1200 mm
- Panel height: 30 – 50 mm

Custom dimensions on request

Water capacity: *

Mass storage capacity:
up to 20 W/m² panel area

A11-S, SPECTRA M-S
Cooling: up to 125 W/m² (ΔT: 8 K)
at 85 % Aar

Heating: up to 117 W/m² (ΔT: 15 K)

With flowing supply air, there will be a 20 to 40 % higher heating capacity.



* Cooling capacity based on DIN EN 14240/heating capacity based on DIN EN 14037 : 2016
Higher capacities possible on a project-specific basis. Aar = Active area ratio.

AQUILO

Hybrid system with building mass connection



- In combination with A11-S, A11-C, SPECTRA M-S, SPECTRA M-C
- Very high heating & cooling capacity
- Superior sound absorption values (class A)
- Building mass connection (A11-C, SPECTRA M-C)
- Sound power level L_w : < 25 dB (A)
- Fresh air intake is silent and draught-free thanks to ceiling panel perforations

Dimensions:

Installation height: 150 – 220 mm

- Panel length: 800 – 3000 mm
- Panel width: 400 – 1200 mm
- Panel height: 30 – 50 mm

Custom dimensions on request

Water capacity: *

Mass storage capacity:

Sail up to 10 W/m² panel area

Closed ceiling: up to 5 W/m² panel area

A11-S, SPECTRA M-S

Cooling: up to 122 W/m² (ΔT : 8 K)
at 85 % Aar

Heating: up to 138 W/m² (ΔT : 15 K)

A11-C, SPECTRA M-C

Cooling: up to 114 W/m² (ΔT : 8 K)
at 75 % Aar

Heating: up to 113 W/m² (ΔT : 15 K)



VENTAMIC

Hybrid system with building mass connection



- In combination with A11-C, SPECTRA M-C
- Very high heating & cooling capacity
- Superior sound absorption values (class A)
- Building mass connection
- Sound power level L_w : < 35 dB (A)
- Fresh air intake is silent and draught-free

Dimensions:

Installation height: min. 250 mm

- Panel length: 600 – 3000 mm
- Panel width: 400 – 1200 mm
- Panel height: 40 mm

Custom dimensions on request

Water capacity: *

Mass storage capacity:

up to 10 W/m² panel area

A11-C, SPECTRA M-C

Cooling: up to 119 W/m² (ΔT : 8 K)
at 75 % Aar

Heating: up to 104 W/m² (ΔT : 15 K)



* Cooling capacity based on DIN EN 14240/heating capacity based on DIN EN 14037 : 2016
Higher capacities possible on a project-specific basis. Aar = Active area ratio.

Subject to technical changes.

A11-S

Climate metal ceiling sail



- Very high heating & cooling capacity
- Superior sound absorption values (class A)
- Easy installation
- Low system weight
- Variable coil design
- Components can be integrated
- Can be combined with ARCHISONIC®, AQUILO, CAURUS

Dimensions:

Installation height: min. 80 mm

- Panel length: 800 – 3000 mm
- Panel width: 400 – 1200 mm
- Panel height: 30 – 50 mm

Custom dimensions on request

Water capacity: *

Cooling: up to 105 W/m² (ΔT: 8 K)
at 85 % Aar

Heating: up to 117 W/m² (ΔT: 15 K)

With Convector Wings:

Cooling: up to 122 W/m² (ΔT: 8 K)
at 85 % Aar

Heating: up to 117 W/m² (ΔT: 15 K)



SPECTRA M-S

Climate metal ceiling sail with magnet technology



- Very high heating & cooling capacity
- Superior sound absorption values (class A)
- Ceiling panels and activation coils are connected using magnetic technology
- Tool-free fitting and removal of the coils
- Fully recyclable by material type
- Components can be integrated
- Can be combined with AQUILO, CAURUS

Dimensions:

Installation height: min. 80 mm

- Panel length: 800 – 3000 mm
- Panel width: 400 – 1200 mm
- Panel height: 30 – 40 mm

Custom dimensions on request

Water capacity: *

Cooling: up to 91 W/m² (ΔT: 8 K)
at 85 % Aar

Heating: up to 102 W/m² (ΔT: 15 K)



VARICOOL TKM

Currently only available in Switzerland

Climate textile ceiling sail



- In combination with CAURUS
- Very high heating & cooling capacity
- Advanced sound absorption values (class B)
- Building mass connection
- Fresh air intake is silent and draught-free
- Components can be integrated

Dimensions:

Installation height: 180 – 500 mm

- Textile length: 1040 mm – 50 m
- Textile width: 740 – 4940 mm
- System height: 137 mm

Custom dimensions on request

Water capacity: *

Cooling: up to 95 W/m² (ΔT: 8 K)

Heating: up to 103 W/m² (ΔT: 15 K)



* Cooling capacity according to DIN EN 14240/heating capacity according to DIN EN 14037 : 2016
Higher capacities possible on a project-specific basis. Aar = Active area ratio.

AKUSTIKTHERM

For thermal active building systems (TABS)



- For buildings with component activation (TABS)
- Superior sound absorption values (class A)
- Very low influence on the thermally active building system during cooling/heating
- Low installation height
- No maintenance required
- Product components can be recycled
- Components can be integrated

Dimensions:

Installation height: 60 – 500 mm

- Panel length: 800 – 3000 mm
- Panel width: 400 – 1200 mm
- Panel height: 30 – 50 mm

Custom dimensions on request

Energy transfer TABS

90 - 94 %



A11-C

Climate metal ceiling

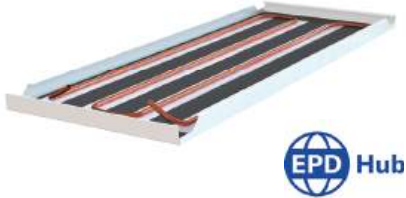

- Very high heating & cooling capacity
- Advanced sound absorption values (class B)
- Can be combined with all common metal ceiling systems
- Low system weight
- High thermal comfort in rooms with large heating loads
- Components can be integrated
- Can be combined with VENTAMIC, AQUILO, ARCHISONIC®

Dimensions:

Installation height: min. 100 mm

- Panel length: 600–3000 mm
- Panel width: 400–1200 mm
- Panel height: 30–50 mm

Custom dimensions on request

Water capacity: *

Cooling: up to 100 W/m² (ΔT: 8 K)
at 75 % Aar

Heating: up to 116 W/m² (ΔT: 15 K)



SPECTRA M-C

Climate metal ceiling with magnetic technology



- High heating & cooling capacity
- Advanced sound absorption values (class B)
- Ceiling panels and activation coils are connected using magnetic technology
- Tool-free fitting and removal of the coils
- Fully recyclable by material type
- Existing metal ceilings can be retrofitted with the SPECTRA M magnetic system
- Components can be integrated
- Can be combined with AQUILO, VENTAMIC

Dimensions:

Installation height: min. 100 mm

- Panel length: 600–3000 mm
- Panel width: 400–1200 mm
- Panel height: 30–40 mm

Custom dimensions on request

Water capacity: *

Cooling: up to 83 W/m² (ΔT: 8 K)
at 75 % Aar

Heating: up to 87 W/m² (ΔT: 15 K)



ECO M-C

Currently not available in Switzerland

Climate metal ceiling with magnetic technology

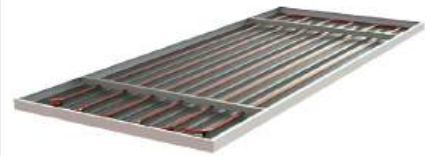

- High heating & cooling capacity
- Advanced sound absorption values (class B)
- Ceiling panels and activation coils are connected using magnetic technology
- Tool-free fitting and removal of the coils
- Fully recyclable by material type
- Existing metal ceilings can be retrofitted with the ECO M magnetic system
- Components can be integrated

Dimensions:

Installation height: 200 mm

- Panel length: 500–2000 mm
- Panel width: 300–800 mm
- Panel height: 30–40 mm

Custom dimensions on request

Water capacity: *

Cooling: up to 80 W/m² (ΔT: 8 K)
at 65 % Aar

Heating: up to 80 W/m² (ΔT: 15 K)



* Cooling capacity according to DIN EN 14240/heating capacity according to DIN EN 14037 : 2016
Higher capacities possible on a project-specific basis. Aar = Active area ratio.

VARICOOL UNI

Jointless climate ceiling



- High heating & cooling capacity
- Acoustically effective (class C)
- Can be used as a closed climate ceiling or sail
- Coils are easy to install
- Coils replace parts of the substructure
- Full-surface ceiling activation possible
- Components can be integrated

Register dimensions:

Installation height: min. 120 mm
- Register length: 500 – 2500 mm
- Register width: 180 – 1000 mm
- Register height: 27 mm

Custom dimensions on request

Water capacity: *

Cooling: up to 77 W/m² (ΔT: 8 K)
at 65 % Aar

Heating: up to 103 W/m² (ΔT: 15 K)



VARICOOL AP

Jointless climate ceiling



- High heating & cooling capacity
- Acoustically effective (class C)
- Can be used as a closed climate ceiling or sail
- Activation profiles are easy to install
- Profiles replace parts of the substructure
- Flexible profile arrangements possible
- Components can be integrated

Profile dimensions:

Installation height: min. 120 mm
- Profile length: 1000 – 3000 mm
- Profile width: 135 mm
- Profile height: 27 mm

Custom dimensions on request

Water capacity: *

Cooling: up to 82 W/m² (ΔT: 8 K) alu
at 85 % Aar

Heating: up to 118 W/m² (ΔT: 15 K) alu

Cooling: up to 67 W/m² (ΔT: 8 K) plaster
at 85 % Aar

Heating: up to 104 W/m² (ΔT: 15 K) plaster



ARCHISONIC®

Acoustic baffle



- In combination with A11-S, A11-C, ALBATROS
- High to very high heating & cooling capacity
- Superior sound absorption values (class A)
- Sustainable and high quality acoustic material made from PET
- Quick and easy installation
- Versions: Edge, Straight & Wave
- 45 different colours to choose from
- Components can be integrated

Baffle dimensions:

Installation height: min. 240 mm
- Baffle length: 400 – 1800 mm
- Baffle width: 24 mm
(88 PET bottles/m²)
- Baffle height: 150 mm

Custom dimensions on request

Water capacity:*

Cooling: up to 70 W/m² (ΔT: 8 K) A11-S
Heating: up to 90 W/m² (ΔT: 15 K) A11-S

Cooling: up to 60 W/m² (ΔT: 8 K) A11-C
Heating: up to 82 W/m² (ΔT: 15 K) A11-C

Cooling: up to 190 W/m² (ΔT: 8 K) ALBATROS
Heating: up to 233 W/m² (ΔT: 15 K) ALBATROS



* Cooling capacity according to DIN EN 14240 / heating capacity according to DIN EN 14037 : 2016
Higher capacities possible on a project-specific basis. Aar = Active area ratio.

ALBATROS

High performance module



- Very high heating & cooling capacity
- With optional absorbers: Superior sound absorption values (class A)
- Powerful and energy efficient
- Exceptional design/performance concept
- Easy installation
- Anodised profiles available
- Components can be integrated
- Can be combined with ARCHISONIC®

Dimensions:

Installation height: min. 220 mm

- Module length: 1000 – 2500 mm
- Module width: 290 – 990 mm
- Module height: 160 mm
- Pipe rows: 3 – 10
- Pipe spacing: 100 mm

Custom dimensions on request

Water capacity: *

Cooling: up to 241 W/m² (ΔT: 8 K)

Heating: up to 303 W/m² (ΔT: 15 K)



OPTI Y

High performance module

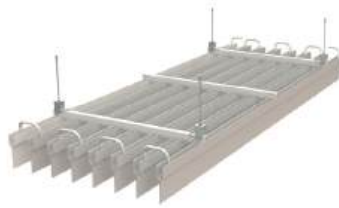

- Very high heating & cooling capacity
- With optional absorbers: Superior sound absorption values (class A)
- Powerful and energy efficient
- Can be combined with any ventilation system
- Easy installation
- Visible or concealed installation possible depending on visual requirements
- Anodised profiles available
- Components can be integrated

Dimensions:

Installation height: min. 250 mm

- Module length: 1000 – 2500 mm
- Module width: 230 – 1080 mm
- Module height: 216 mm
- Pipe rows: 3 – 10
- Pipe spacing: 100/150 mm

Custom dimensions on request

Water capacity: *

Cooling: up to 198 W/m² (ΔT: 8 K)

Heating: up to 230 W/m² (ΔT: 15 K)



SOFTLINE

High performance module



- Very high heating & cooling capacity
- With optional absorbers: Advanced sound absorption values (class B)
- Powerful and energy efficient
- Simple installation; option to pivot modules down
- Versions: Curve, Roof & Base (others available on request)
- Anodised profiles available
- Components can be integrated

Dimensions:

Installation height: min. 180 mm

- Module length: 1000 – 2500 mm
- Module width: 380 – 1290 mm
- Module height: 95 mm
- Pipe rows: 3 – 10
- Pipe spacing: 130 mm

Custom dimensions on request

Water capacity: *

Cooling: up to 140 W/m² (ΔT: 8 K)

Heating: up to 135 W/m² (ΔT: 15 K)



* Cooling capacity according to DIN EN 14240/heating capacity according to DIN EN 14037 : 2016
Higher capacities possible on a project-specific basis

SOFTLINE WOOD

High performance module



- High heating and cooling capacity
- With optional absorbers: Advanced sound absorption values (class B)
- Real wood
- Easy installation
- Components can be integrated
- Can be combined with CAURUS

Dimensions with frame:

Installation height: min. 180 mm

- Module length: 1050 – 2550 mm
- Module width: 650 – 1370 mm
- Module height: 60 mm
- Pipe rows: 3 – 6
- Pipe spacing: 240 mm

Custom dimensions on request

Water capacity: *

Cooling: up to 90 W/m² (ΔT : 8 K)
Heating: up to 86 W/m² (ΔT : 15 K)



METAL LINE

Climate baffle

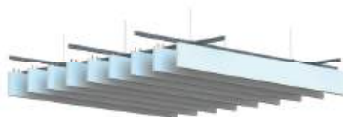

- Very high heating & cooling capacity
- Acoustically effective (class C)
- Quick and easy installation
- Suitable for retrofitting
- Available in various designs (colours, wood appearance, etc.)
- Components can be integrated

Dimensions:

Installation height: min. 260 mm

- Baffle length: 500 – 2500 mm
- Baffle width: 30 / 40 mm
- Baffle height: 200 mm

Custom dimensions on request

Water capacity: *

Cooling: up to 22 W/lm (ΔT : 8 K)
at 90 % Aar
Heating: up to 25 W/lm (ΔT : 15 K)



* Cooling capacity according to DIN EN 14240 / heating capacity according to DIN EN 14037 :
Higher capacities possible on a project-specific basis. Aar = Active area ratio.
Subject to technical changes.



Room management systems

WISE / SuperWISE

Did you know that on average we spend 87 % of our time indoors? And that we inhale about 15 kg of air per day? To ensure a pleasant indoor climate, multiple factors such as air quality, thermal climate, air humidity, air speed, sound, and lighting must be taken into consideration. An effective room management system can significantly impact these factors.

This is how WISE works

WISE acts as the brain for the indoor climate, gathering data from the property and optimising the indoor climate accordingly. The data can include everything from temperature and air quality to occupancy. We call this demand-controlled indoor climate.

WISE is a scalable system, which means that Swegon can offer solutions for all types of properties, large and small alike. Swegon helps to create unique climate solutions for our customers' varying needs. Generally speaking, WISE is best suited to properties where the occupancy rate varies over time, such as schools and offices. When your occupancy rate varies, for example, this means that you do not need to ventilate 24 hours a day. It is sufficient to ventilate when people are present – demand-controlled, quite simply!

Wireless connectivity

WISE communicates wirelessly, which has many advantages:

- The system can be started up and commissioned quickly! The system's components are digitally matched with the role they assume in the system.
- Ease of installation – The installation time is reduced and the risk of misconnections is eliminated.
- Flexible configuration – If a wall is taken down in the building, the components can be assigned new roles without having to re-run a single cable.

Components in WISE

WISE incorporates a range of different products that combine to create the smart system.

System products – These act as small brains, where all the intelligence and data are gathered.

Climate products – The system's climate products handle air, heating and cooling for a perfect indoor climate. These products are situated in the room, e.g. air diffusers and comfort modules.

System accessories – Various types of transducers and sensors that detect e.g. temperature, air quality and occupancy.

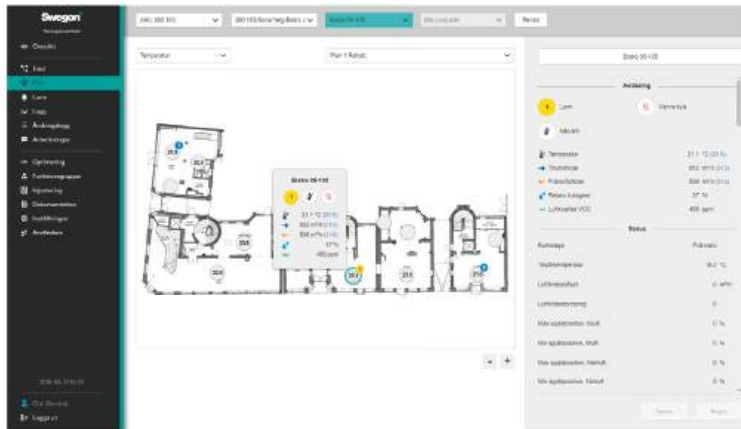

SuperWISE

Our SuperWISE interface checks how WISE is performing during commissioning and supervision. It is simple to operate and easy to identify any anomalies from what is expected. Using SuperWISE, the process is not only easier and more efficient, but it also enables you to rest assured that everything is working as it should.

Using WISE, it is basically possible to control all the elements in a climate system, such as air handling units and climate products. In addition, WISE can also control water and air optimisation. Furthermore, it is possible to add digital services in which products' and properties' data can be visualised and managed.



Play Video





A dependable partner

Decades of experience

Barcol-Air is your professional partner. We have gained decades of experience in the construction and installation of climate ceiling systems in many countries around the world.

Expertise

Our employees have in-depth expertise in the field of climate ceiling systems.

We strive to maintain our lead in the industry and consider the training and further development of our employees to be essential in ensuring they remain at the cutting edge of technology.

That is why we always have the resources and expertise required to install and maintain reliable systems for you.

Help and support

We support our customers in all phases of their projects – from the initial idea right through to commissioning the ceiling.

Reference projects



Beyond Gravity Circle, Zurich Airport



Mercato, Duisburg



Porsche Museum, Stuttgart



SXB Südkreuz, Berlin



Vector Informatik, Stuttgart



Mekkah Clock Tower, Mecca

Visit our website: barcolair.com

Feel good **inside**

